

WL600922H  
WL601022H  
WL601122H  
WL502086H  
WL602376H  
WL602322H



Please read the information sheet before proceeding.

## WHAT TO KNOW BEFORE INSTALLING...

1. When positioning the seat onto the pan ensure that the lid and ring can be lifted and remain upright on the pan. In some cases the seat can be obstructed by the cistern or the flush handle which prevents it from staying upright.
2. Before activating the grip pad technology (Step 10) ensure the toilet seat is in a perfect position as it cannot be reused without compromising performance.
3. To remove the seat at the end of its use, use a scraper to carefully lever the hinge away from the toilet pan.

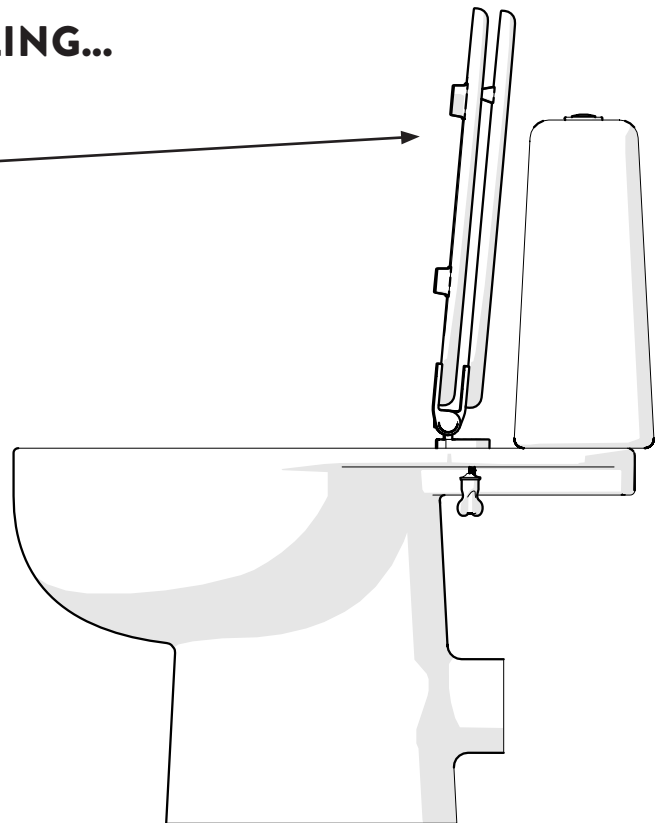

Croydex, Central Way, Andover,  
Hampshire, SP10 5AW, UK



+44 (0) 1264 365881



+44 (0) 1264 356437



info@croydex.co.uk



www.croydex.com

**TS 043 R02**



For reference only



Parts may vary.  
(Optional)



Warning! Please  
take special care.

**PLEASE READ ALL OF THE INFORMATION CAREFULLY AND REFER BACK WHEN YOU SEE THE NUMBERED ICONS THROUGHOUT INSTRUCTIONS.**

**SAFETY AND CARE (EN)**

- 1 To retain the best quality finish, clean product with a soft cloth and a mild soap solution.
- 2 Do not use abrasive or chemical cleaners as they may damage the surface of the toilet seat or hinges.
- 3 Spray cleaning liquids onto the cloth and not directly onto the product.
- 4 Take care when cleaning the toilet pan with chemical cleaners. Avoid contact of the chemical cleaners with the toilet seat or hinges. Immediately rinse off any splashes to avoid damage or discolouration to the surface of the toilet seat and hinge parts.

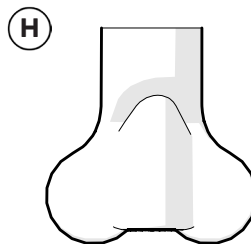
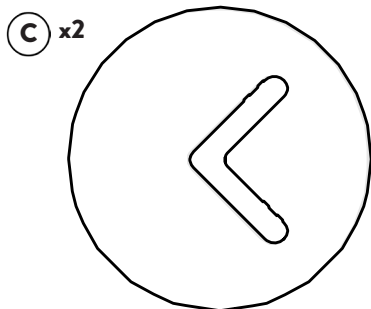
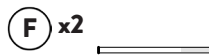
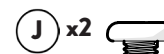
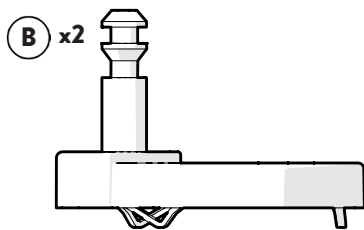
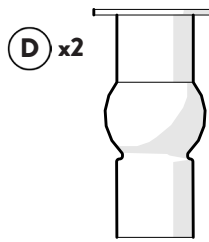
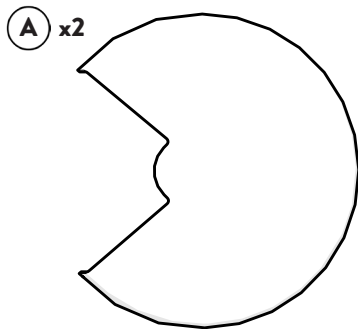

# 1. BEFORE YOU BEGIN

## PREPARATION

- Remove the old seat from the pan and clean the surface around the fixing holes.
- Ensure the surfaces around the fixing holes are completely dry before beginning the installation.

## PLACEMENT

In its sealed packaging place the seat over your pan to ensure you are happy with size and shape of the toilet seat.

## HELPFUL ADVICE

To ensure you do not lose any components down the toilet you may want to place cling film over the bowl of the toilet.

# 2.

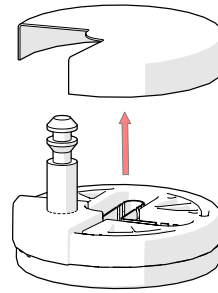

Remove the decorative caps from the hinges.

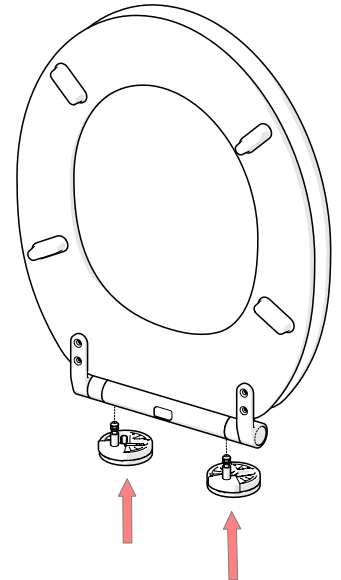

Place hinges into the toilet seat.

# 3.

Ensure hinges are in the correct alignment allowing you to position the seat on your pan.

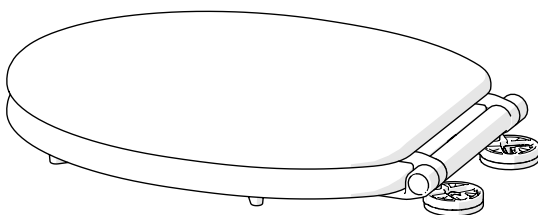
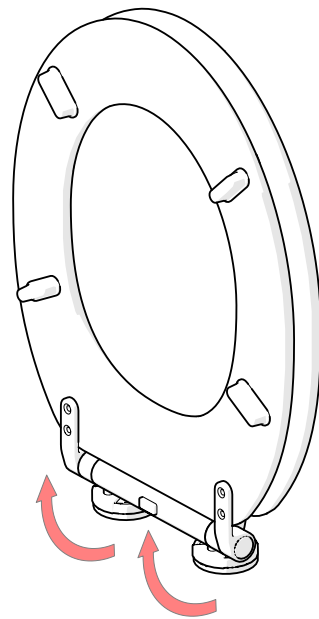

# 4.

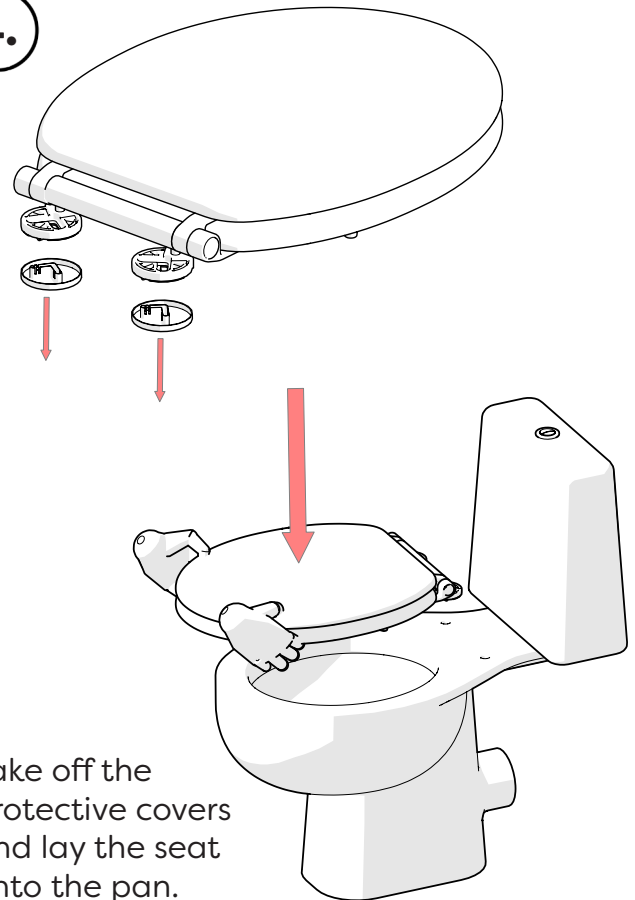

Take off the protective covers and lay the seat onto the pan.

# 3.

 Croydex, Central Way, Andover, Hampshire, SP10 5AW, UK

 +44 (0) 1264 365881

 +44 (0) 1264 356437

 info@croydex.co.uk

 www.croydex.com

**TS 043 R02**

5.

5a.

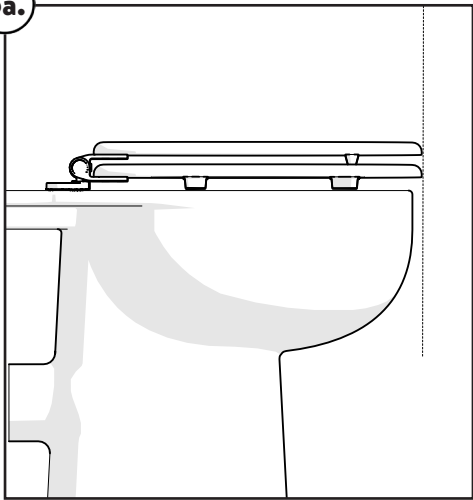

5a.

Align the seat with the front of the toilet pan.

5b.

Rotate the hinges bases until you align the V shaped slot with the fixing holes of the toilet pan.

5b.

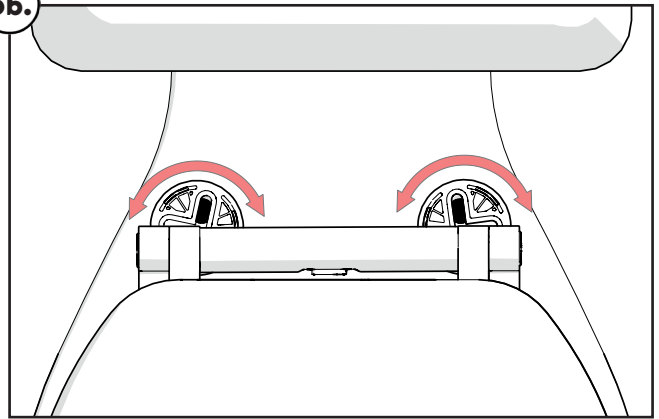

5b.

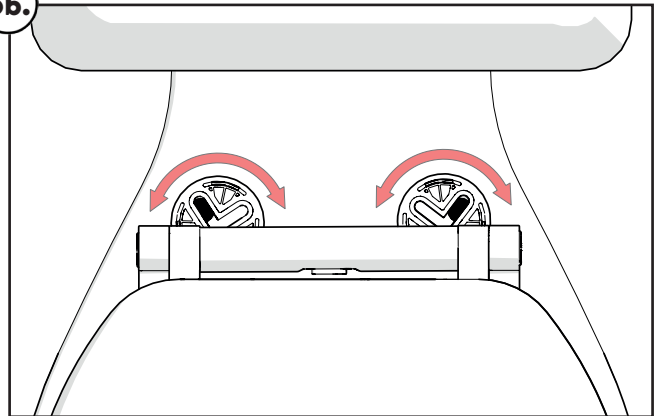

\*Hinge positions should be symmetrical.

6.

Remove the protective film to reveal the grip pad and place bolts into the hinge base.

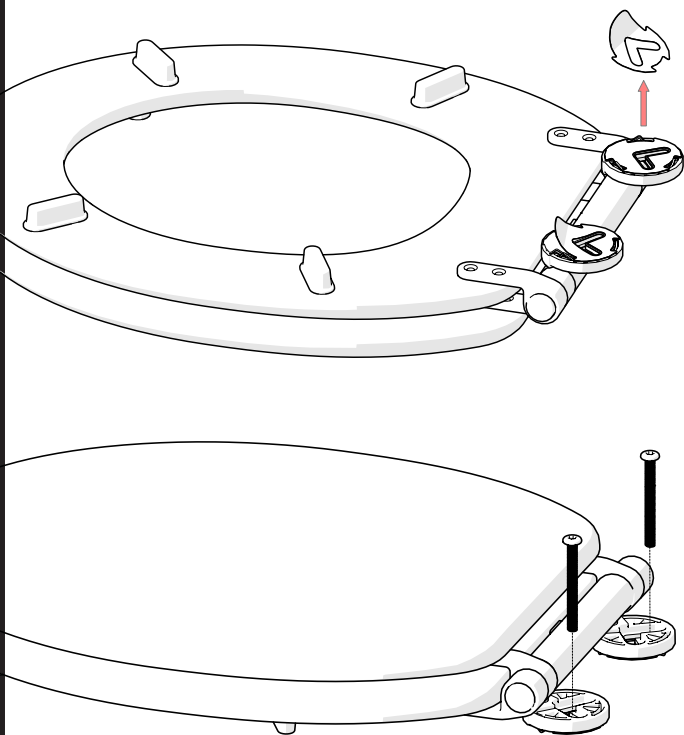

7.

### TOP OR BOTTOM FIXINGS?

#### TOP FIX

- Fits most toilet pans.
- Suitable for back to wall pans.
- No need to reach underneath the toilet pan.

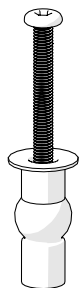

OR

#### BOTTOM FIX

- Faster installation.

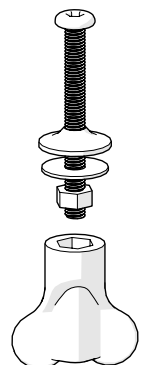

4.



Croydex, Central Way, Andover, Hampshire, SP10 5AW, UK



+44 (0) 1264 356437



www.croydex.com



+44 (0) 1264 365881



info@croydex.co.uk

**TS 043 R02**

8.

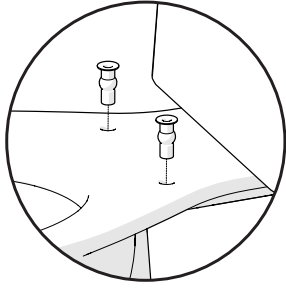

For top fix, insert the rubber plugs into the holes in the toilet pan.



Carefully place the seat on the pan ensuring the Grip Pad does not stick to the pan surface at this stage of installation.

9.

Lightly screw the bolt into place using your chosen fixing method. **Do not collapse the supports on the hinge base yet.**

**BOTTOM FIX**

**TOP FIX**

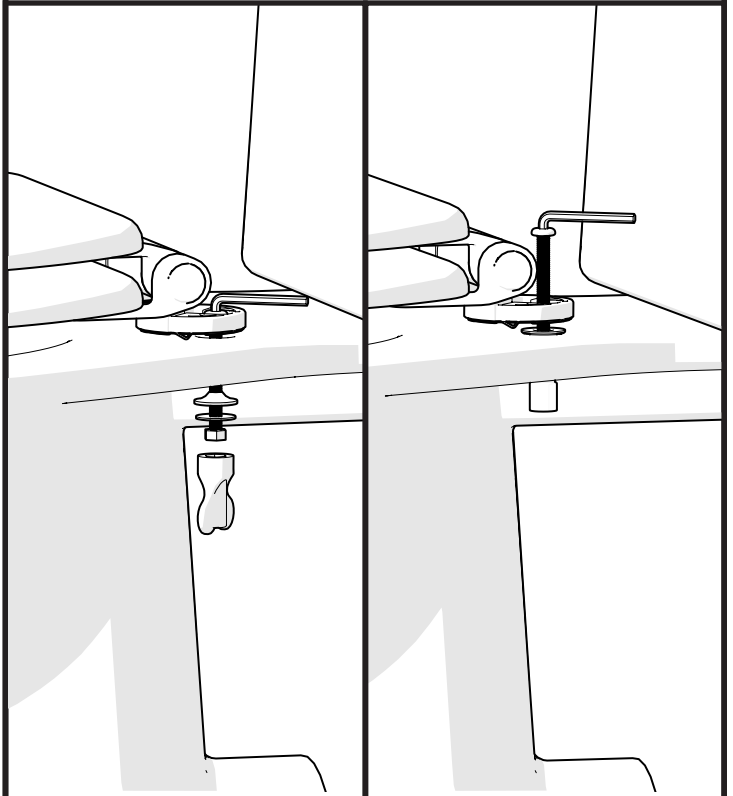

10.

Complete a final check to ensure that you are happy with the position of the seat. Then apply pressure to the hinges to collapse the supports allowing the grip pad to bond to the toilet pan.

Hold for at least 20 seconds.

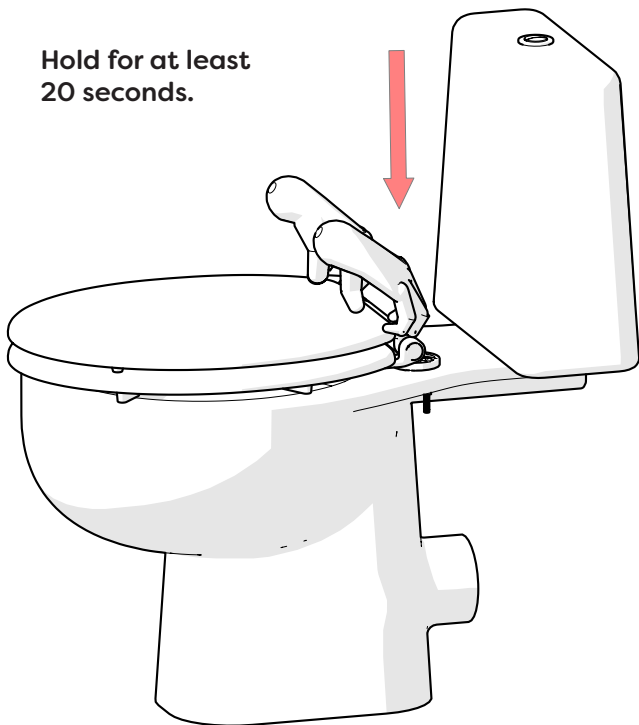

11.

Removing the seat at this stage will make it easier to fully tighten the fixing brackets. Firstly lift up the lid while retaining pressure on the ring to ensure the brackets do not move. *Steps 12, 13, 14 are completed together.*

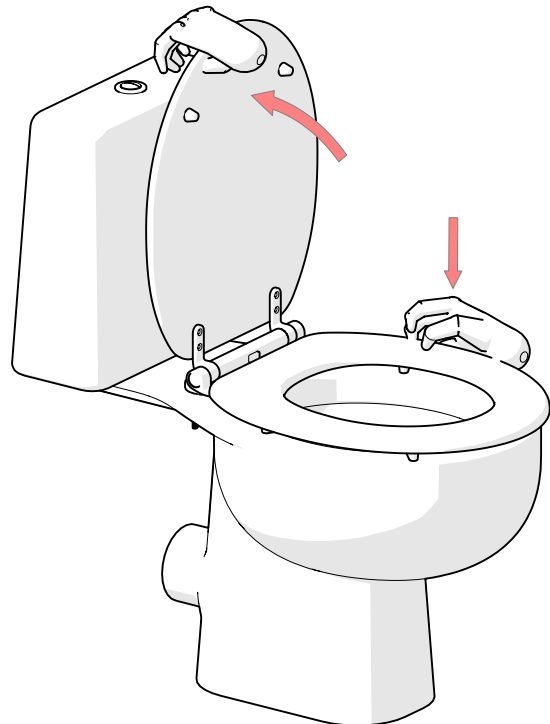

5.



Croydex, Central Way, Andover, Hampshire, SP10 5AW, UK



+44 (0) 1264 356437



www.croydex.com



+44 (0) 1264 365881



info@croydex.co.uk

**TS 043 R02**

12.

Lift the ring upright whilst ensuring the hinges are not moved. Lifting the lid and ring separately will help ensure the hinges are not moved.



PRESS

13.

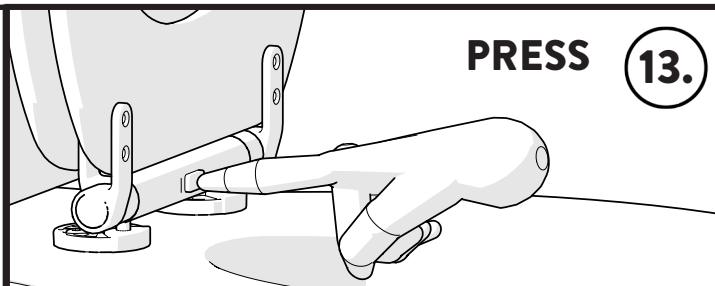

RELEASE

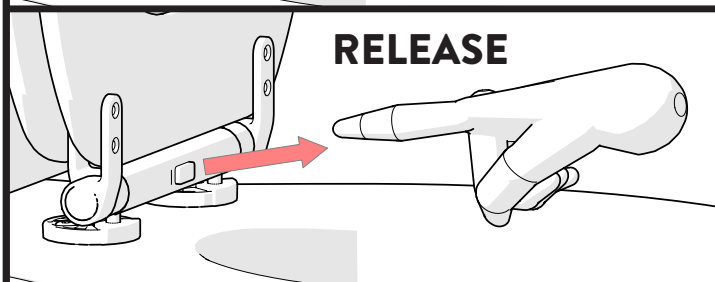

LIFT

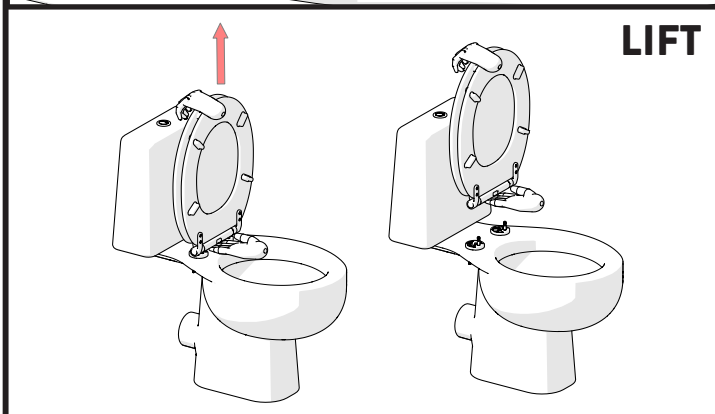

14.

Fully tighten the bolt using your preferred fixing method.

**BOTTOM FIX**

**TOP FIX**

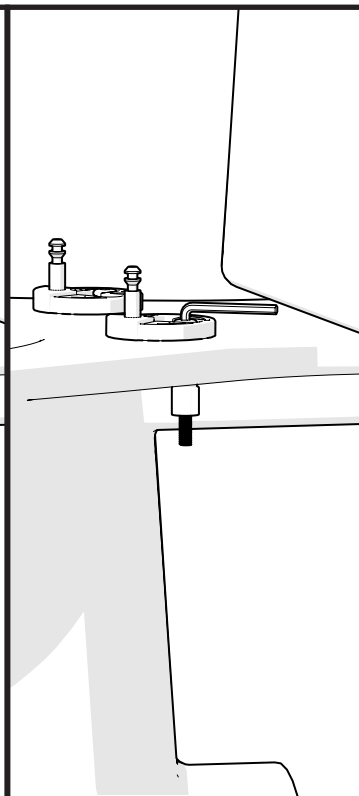
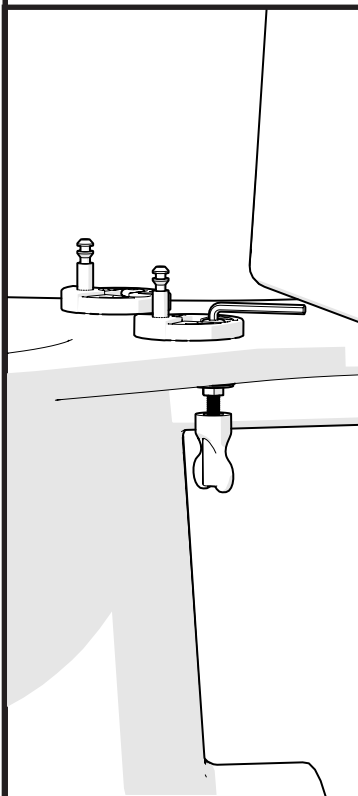

15.

Place on the decorative caps and push lock the seat onto the hinges.

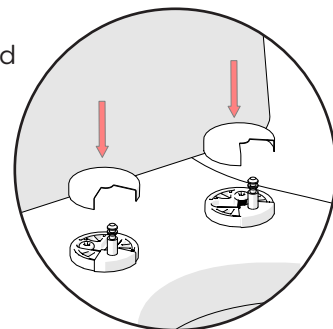

6.

 Croydex, Central Way, Andover, Hampshire, SP10 5AW, UK

 +44 (0) 1264 356437

 [www.croydex.com](http://www.croydex.com)

 +44 (0) 1264 365881

 [info@croydex.co.uk](mailto:info@croydex.co.uk)

**TS 043 R02**